

CARATTERISTICHE:

Griglie a maglia quadra
13x13 mm.

COSTRUZIONE:

Alluminio anodizzato.
Maglia quadra inclinata di 45°
per il modello GMAI.

IMPIEGO:

A parete, in ripresa.

FISSAGGIO:

- Fissaggio standard con clips.
- Fori per viti a richiesta.
- Calamite a richiesta (CL).
- Morsetti a richiesta (KC).

ACCESSORI:

- Plenum in acciaio zincato standard e isolato.
- Serranda di taratura in acciaio zincato con alette a movimento contrapposto.
- Controtelaio di montaggio in lamiera di acciaio zincata.

CHARACTERISTICS:

Egg crate grilles
13x13 mm pitch.

CONSTRUCTION:

Anodized aluminium
Square-grid inclined of 45° on
model GMAI.

UTILIZATION:

For wall installation and for
air intake.

FIXING:

- Standard fixing by clips.
- Holes for screws upon request.
- Magnets on request (CL).
- Lock upon request (KC).









ACCESSORIES:

- Galvanized steel plenum, standard or insulated.
- Calibration damper made of galvanized steel and fins with opposite movement.
- Mounting counterframes made of galvanized steel sheet.

PREZZI - PRICES

BxH	GMA	GMAI	SC	CT CTKC	PBZ1	PBZ11	PBZ2	PBZ12
mm	€	€	€	€	€	€	€	€
200x100								
300x100								
400x100								
500x100								
600x100								
800x100								
1000x100								
1200x100								
200x150								
300x150								
400x150								
500x150								
600x150								
800x150								
1000x150								
1200x150								
200x200								
300x200								
400x200								
500x200								
600x200								
800x200								
1000x200								
1200x200								
200x300								
300x300								
400x300								
500x300								
600x300								
800x300								
1000x300								
1200x300								
200x400								
300x400								
400x400								
500x400								
600x400								
800x400								
1000x400								
1200x400								
200x500								
300x500								
400x500								
500x500								
600x500								

PREZZI - PRICES

								
BxH	GMA	GMAI	SC	CT CTKC	PBZ1	PBZ11	PBZ2	PBZ12
mm	€	€	€	€	€	€	€	€
800x500								
1000x500								
1200x500								
200x600								
300x600								
400x600								
500x600								
600x600								
800x600								
1000x600								
1200x600								
200x800								
300x800								
400x800								
500x800								
600x800								
800x800								
1000x800								
1200x800								

VERNICIATURA - PAINTING:

Colori RAL 9010 - 9016: + 15% - Color RAL 9010 - 9016: + 15%

Altri colori: prezzi a richiesta - Different colors: prices on request

DESCRIZIONI - DESCRIPTIONS:**GMA:** Griglia a maglia quadrata - Egg crate grille**GMAI:** Griglia a maglia quadrata inclinata 45° - Egg crate grille 45° deflection (to reduce visibility through the grille)

DISEGNI - DRAWINGS

GRI

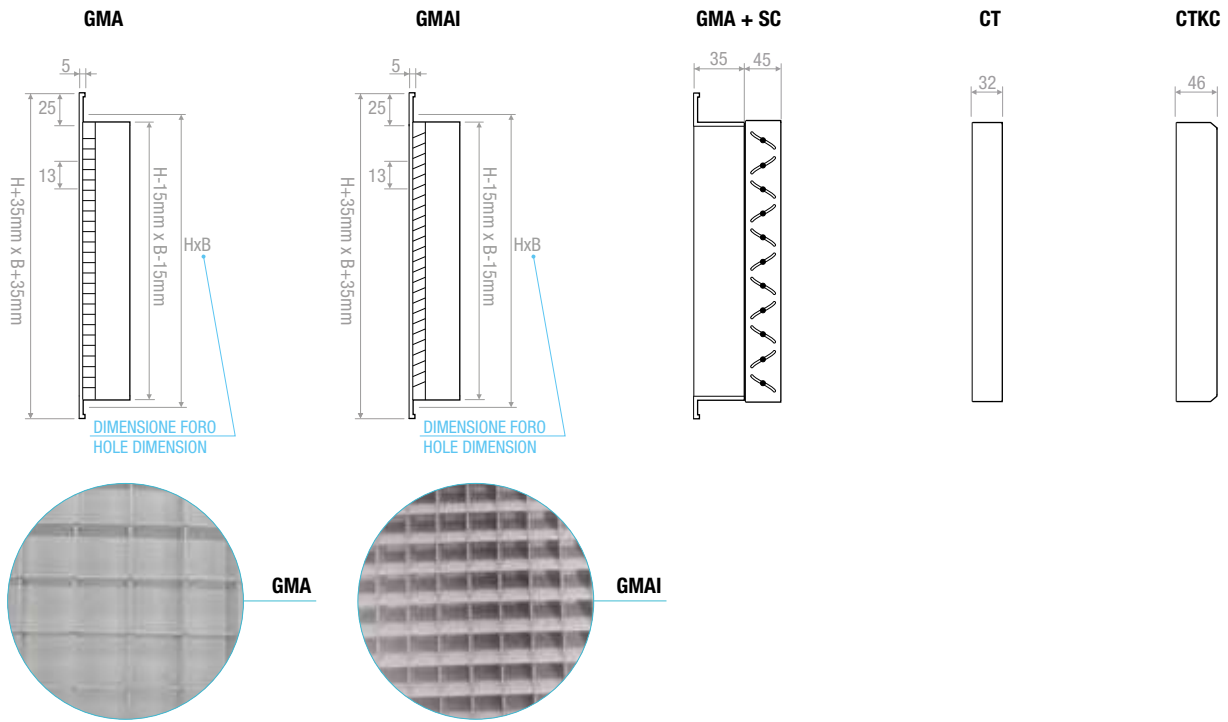

TIPO DI FISSAGGIO - TYPE OF FIXING

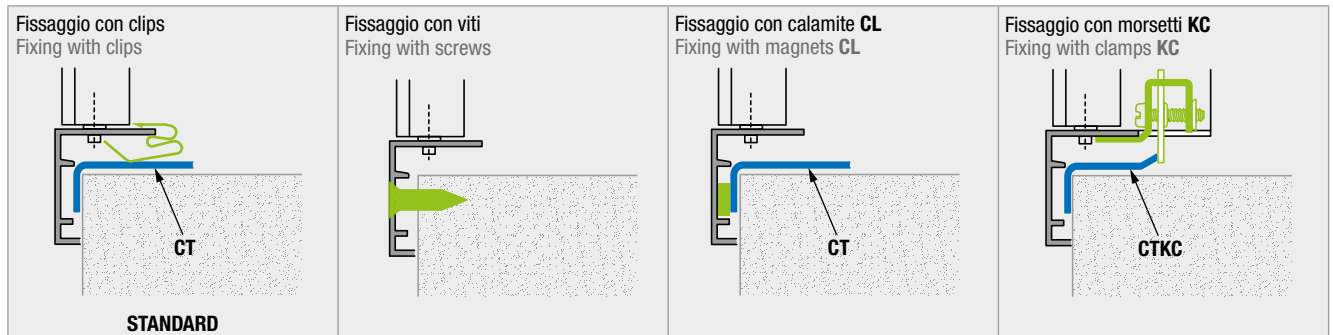

CL: € cadauna - each
Ogni griglia - Each grille: 4 CL

KC: € cadauna - each
da - from 200x100 a - to 1000x300: 2 KC
da - from 400x400 a - to 1000x500: 4 KC

FORI - HOLE

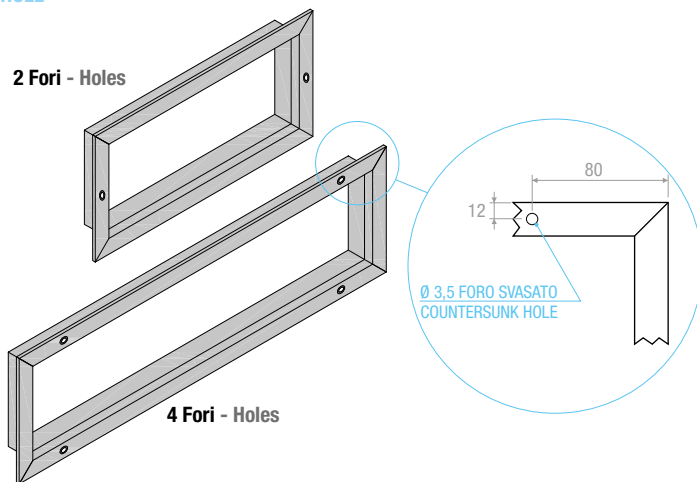

Quantità di fori per le viti di fissaggio Amount of holes for mounting screw					
Lato minore Smaller side	Lato maggiore - Longer side				
	200	250	300	350	≥400
100	2	2	2	4	4
150	2	2	2	4	4
200	2	2	2	4	4
≥250	2	2	2	4	4

DISEGNI - DRAWINGS

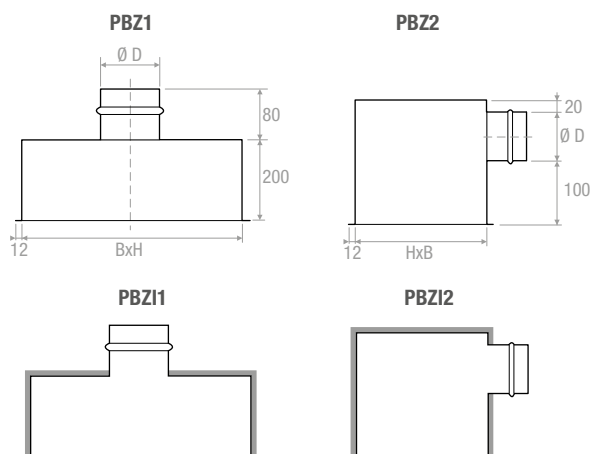

Plenum isolato esternamente spessore 6 mm
Plenum externally insulated thickness 6 mm

DIAGRAMMA SCELTA RAPIDA - QUICK SELECTION DIAGRAM

GRI



TABELLA DI SELEZIONE - SELECTION TABLE

Modello - Model	A _k [m ²]	Q [m ³ /h]		L _{wa} [dB(A)]		Dp _t [Pa]	
		min	max	min	max	min	max
GMA 200x100	0,0111	140	270	-	38	5	20
GMA 300x100	0,0176	220	430	22	41	5	20
GMA 400x100	0,0245	300	590	23	42	5	20
GMA 500x100	0,0316	390	760	24	43	5	20
GMA 600x100	0,0390	480	940	25	44	5	20
GMA 800x100	0,0542	660	1300	26	46	5	20
GMA 1000x100	0,0700	850	1670	27	47	5	20
GMA 1200x100	0,0863	1040	2060	28	48	5	20
GMA 200x150	0,0176	220	430	22	41	5	20
GMA 300x150	0,0280	340	680	23	43	5	20
GMA 400x150	0,0390	480	940	25	44	5	20
GMA 500x150	0,0504	610	1210	26	45	5	20
GMA 600x150	0,0621	750	1490	27	46	5	20
GMA 800x150	0,0863	1040	2060	28	48	5	20
GMA 1000x150	0,1115	1340	2650	29	49	5	20
GMA 1200x150	0,1374	1650	3250	30	50	5	20
GMA 200x200	0,0245	300	590	23	42	5	20
GMA 300x200	0,0390	480	940	25	44	5	20
GMA 400x200	0,0542	660	1300	26	46	5	20
GMA 500x200	0,0700	850	1670	27	47	5	20
GMA 600x200	0,0863	1040	2060	28	48	5	20
GMA 800x200	0,1201	1440	2850	30	49	5	20
GMA 1000x200	0,1550	1860	3660	31	50	5	20
GMA 1200x200	0,1911	2280	4500	32	51	5	20
GMA 200x300	0,0390	480	940	25	44	5	20
GMA 300x300	0,0621	750	1490	27	46	5	20
GMA 400x300	0,0863	1040	2060	28	48	5	20
GMA 500x300	0,1115	1340	2650	29	49	5	20
GMA 600x300	0,1374	1650	3250	30	50	5	20
GMA 800x300	0,1911	2280	4500	32	51	5	20
GMA 1000x300	0,2468	2940	5790	33	52	5	20
GMA 1200x300	0,3042	3610	7110	34	53	5	20
GMA 200x400	0,0542	660	1300	26	46	5	20
GMA 300x400	0,0863	1040	2060	28	48	5	20
GMA 400x400	0,1201	1440	2850	30	49	5	20
GMA 500x400	0,1550	1860	3660	31	50	5	20
GMA 600x400	0,1911	2280	4500	32	51	5	20
GMA 800x400	0,2657	3160	6230	33	53	5	20
GMA 1000x400	0,3432	4070	8010	34	54	5	20
GMA 1200x400	0,4230	5000	9850	35	55	5	20
GMA 200x500	0,0700	850	1670	27	47	5	20
GMA 300x500	0,1115	1340	2650	29	49	5	20
GMA 400x500	0,1550	1860	3660	31	50	5	20
GMA 500x500	0,2002	2390	4710	32	51	5	20
GMA 600x500	0,2468	2940	5790	33	52	5	20
GMA 800x500	0,3432	4070	8010	34	54	5	20
GMA 1000x500	0,4433	5240	10310	35	55	5	20
GMA 1200x500	0,5463	6430	12670	36	56	5	20
GMA 200x600	0,0863	1040	2060	28	48	5	20
GMA 300x600	0,1374	1650	3250	30	50	5	20
GMA 400x600	0,1911	2280	4500	32	51	5	20
GMA 500x600	0,2468	2940	5790	33	52	5	20
GMA 600x600	0,3042	3610	7110	34	53	5	20
GMA 800x600	0,4230	5000	9850	35	55	5	20
GMA 1000x600	0,5463	6430	12670	36	56	5	20
GMA 1200x600	0,6733	7910	15570	37	57	5	20
GMA 200x800	0,1201	1440	2850	30	49	5	20
GMA 300x800	0,1911	2280	4500	32	51	5	20
GMA 400x800	0,2657	3160	6230	33	53	5	20
GMA 500x800	0,3432	4070	8010	34	54	5	20
GMA 600x800	0,4230	5000	9850	35	55	5	20
GMA 800x800	0,5883	6920	13630	37	56	5	20
GMA 1000x800	0,7597	8910	17540	38	57	5	20
GMA 1200x800	0,9363	10940	21550	39	58	5	20
GMA 595x595EC	0,2639	3140	6190	33	53	5	20

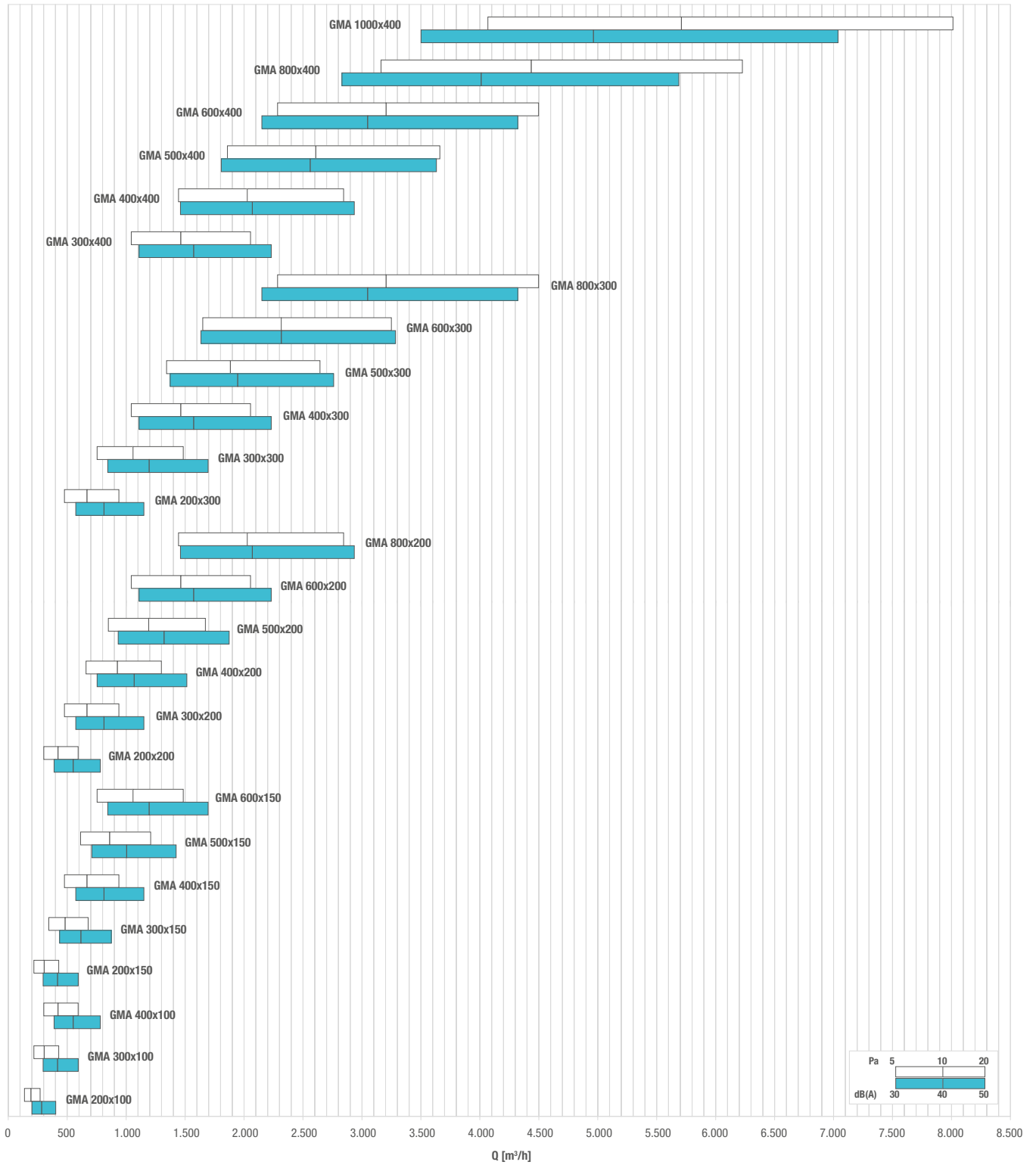